



10th Anniversary

OHIOANA Book Festival

April 23, 2016

10:00 a.m. - 4:30 p.m.

Sheraton Columbus Hotel
at Capitol Square

www.ohioana.org

OHIOANA BOOK FESTIVAL

April 23, 2016 | 10:00a.m.-4:30p.m.

Sheraton at Capitol Square

Columbus, Ohio

www.ohioana.org

BOARD OF TRUSTEES

EX-OFFICIO

Karen Waldbillig Kasich Westerville

ELECTED

Rudine Sims Bishop	<i>President</i>	Columbus
Lisa Evans	<i>Vice-President</i>	Johnstown
Geoffrey Smith	<i>Secretary</i>	Columbus
L. Bradfield Hughes	<i>Treasurer</i>	Columbus
Gillian Berchowitz		Athens
Helen F. Bolte		Columbus
Ann M. Bowers		Bowling Green
Georgeanne Bradford		Cincinnati
Christopher S. Duckworth		Columbus
John F. Furniss III		Lancaster
Bryan Loar		Columbus
Louise S. Musser		Delaware
Claudia Plumley		Columbus
Cynthia Puckett		Columbus
Joan V. Schmutzler		Berea
Daniel Shuey		Westerville
David Sidors		Cincinnati
Robin Smith		Columbus
John Sullivan		Plain City
Yolanda Danyi Szuch		Perrysburg
Jacquelyn L. Vaughan		Dublin

APPOINTED BY THE GOVERNOR

Carl J. Denbow, Ph.D., Athens
Carol Garner, Mount Vernon
H.C. Buck Niehoff, Cincinnati

EMERITUS

Frances Ott Allen, Cincinnati
Christina Butler, Columbus
John Gabel, Avon Lake
James M. Hughes, Dayton
George Knepper, Stow
Robert Webner, Columbus

OHIOANA LIBRARY STAFF

David E. Weaver	<i>Executive Director</i>
Stephanie Michaels	<i>Librarian & Editor</i>
Kathryn Powers	<i>Office Manager</i>
Candy Watkins	<i>Festival Coordinator</i>
Lisa Racine	<i>Ruth Mount Intern</i>

Cover art © David Catrow

OHIOana LIBRARY

Welcome to the 10th anniversary Ohioana Book Festival! We are delighted that you could join us for this fun-filled celebration of reading, writing, books, and Ohio authors. This year's anniversary festival promises to be the biggest, best, and most exciting ever. There's something for every reader of every age: panel discussions on everything from publishing to poetry; a book fair where you can meet your favorite Ohio author; a fun space for kids with story times, balloon twisting, costumed book characters, and crafts. And new this year: a teen space with authors and activities just for young adults. Thanks to the sponsors, contributors, partners, and volunteers for their generous support. Thanks to the 120 amazing Ohio authors (a record number!) sharing their talents here today. Most of all, thank you for coming. The amazing growth the Ohioana Book Festival has had during the past decade would not have been possible without YOU. Thank you—and enjoy the day!

OUR MISSION:

The Ohioana Library collects, preserves, and celebrates Ohio literature and other creative endeavors.

Overview

SECOND FLOOR

- Authors & Book Signings (pp. 4-10, 14-15)
- Poetry in the Plaza (p. 13)
- Barnes & Noble Checkout
- Sponsor & Partner Tables (p. 16)

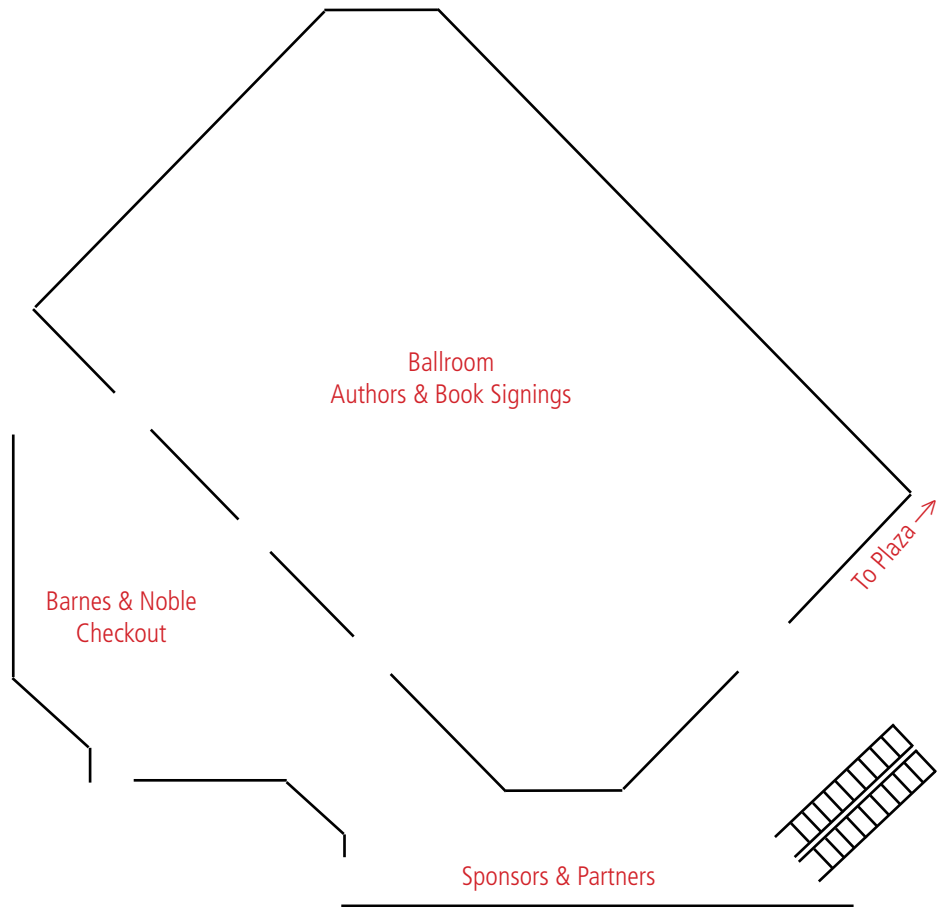

FIRST FLOOR

- Panels & Roundtables (pp. 12-13)
- Teen Space (p. 11)
- Kids' Room (p. 11)

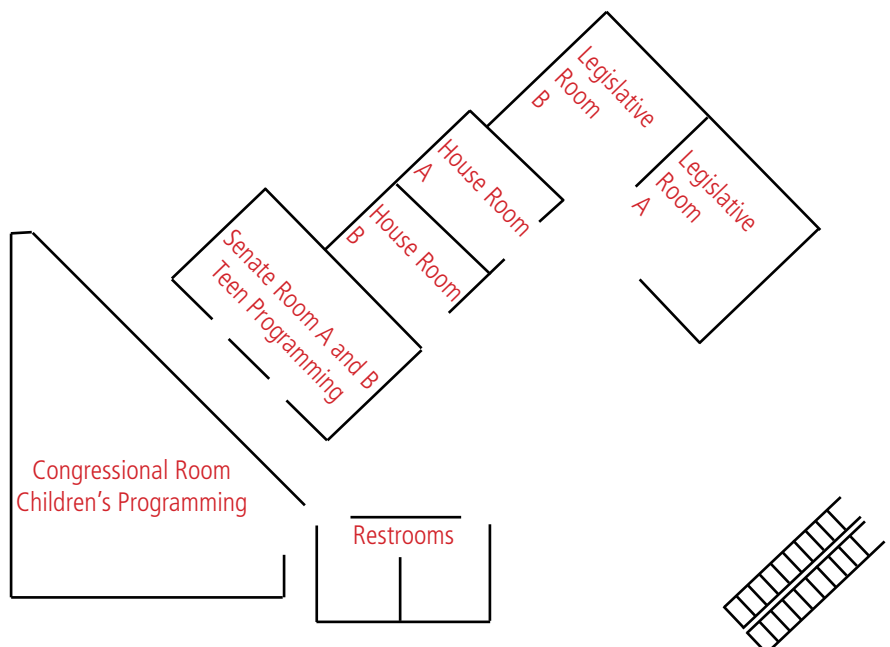

Schedule is subject to change.

Featured Authors

Each year the Ohioana Library invites ten “featured authors” to participate in community literacy and outreach activities. This year’s stellar lineup includes winners of the National Book Award, the Hugo Award, the Peterson Poetry Prize, the Robert F. Kennedy Book Award, and the Ohio Governor’s Award for the Arts. Read more about the 2016 featured authors below.



Jill Bialosky

Jill Bialosky is the author of three previous poetry collections: *The End of Desire*, *Subterranean*, and *Intruder*. Her poems have appeared in journals such as the *Paris Review*, the *Kenyon Review*, the *New Yorker*, and the *Atlantic Monthly*. She is also the author of several novels and the memoir *History of a Suicide: My Sister’s Unfinished Life*. Bialosky is an editor at W.W. Norton and lives in New York City. (Photo by Catherine Sebastian/CSP Images)

Douglas Brinkley

Douglas Brinkley is a professor of history at Rice University, a contributing editor at *Vanity Fair*, and CNN’s official historian. His most recent books are *Cronkite*, *The Quiet World*, and *The Wilderness Warrior*. Six of his books have been selected as *New York Times* Notable Books of the Year. Brinkley lives in Texas with his wife and three children. (Photo by Danny Turner)



David Catrow

David Catrow has created more than seventy illustrated books and has worked extensively in film and television concept/design. His award-winning editorial cartoons have been syndicated in more than 1,000 newspapers in the U.S. and Canada. He works in his studio in the Eastern time zone of the United States where he is supervised by his three dogs, Beetle, Blu, and Stubbie.

Mark Dawidziak

Mark Dawidziak is the television critic at Cleveland’s *Plain Dealer* and the author of many books about Mark Twain and about television. In addition to being a recognized Twain scholar, he has portrayed Mark Twain on stage for thirty-six years. Dawidziak has worked as a television, film, and theater critic for more than thirty-seven years and as an adjunct professor at Kent State University since 2009.



Amanda Flower

Amanda Flower, a three-time Agatha Award-nominated mystery author for children and adults, started her writing career in elementary school when she had her sixth-grade class in stitches with her description of being stuck on top of a Ferris wheel. She knew at that moment she’d found her calling of making people laugh with her words. She also writes mysteries as *USA Today* bestselling author Isabella Alan. In addition to being an author, Amanda is a librarian near Cleveland.



Mindy McGinnis

Mindy McGinnis is a YA author who has worked in a high school library for thirteen years. Her debut, *Not a Drop to Drink*, a post-apocalyptic survival story set in a world with very little freshwater, has been optioned for film by Stephenie Meyer's Fickle Fish Films. The companion novel, *In a Handful of Dust*, was released in 2014. Her Gothic historical thriller, *A Madness So Discreet*, is available now from Katherine Tegen Books.

John Scalzi writes the future from his office in rural Ohio, where he can see Amish buggies roll by. His first science fiction novel, *Old Man's War*, was published in 2005 and was nominated for the Hugo Award (which he later won for *Redshirts*). His novels have placed on the *New York Times* and *USA Today* best-seller lists and have been translated into two dozen languages. His blog, *Whatever*, is one of the oldest in the world (published since 1998) and has a daily audience of tens of thousands.

John Scalzi



Del Sroufe

Del's cooking career began when he was just eight years old, creating dishes from whatever he could find in his father's kitchen. In 1997 Del opened his own vegan bakery, and in 2001 started a vegan Personal Chef Service. In 2006 Del joined Wellness Forum Foods as Executive Chef, delivering great tasting, plant-based meals to clients throughout the continental United States. He has published three vegan cookbooks and continues to teach cooking and health classes.

Leah Stewart is the author of five novels, most recently *The New Neighbor*. Her sixth novel, *What You Don't Know About Charlie Outlaw*, is forthcoming from Putnam. A recipient of an NEA Literature Fellowship and a Sachs Fund Prize, she is a professor at the University of Cincinnati, and lives in Cincinnati with her husband and two children.

Leah Stewart



Jacqueline Woodson

Jacqueline Woodson is the winner of the Margaret A. Edwards Award for lifetime achievement in writing for young adults, the recipient of three Newbery Honors for *After Tupac and D Foster*, *Feathers*, and *Show Way*, and a National Book Award winner for *Brown Girl Dreaming*. Other awards include the Coretta Scott King Award and Los Angeles *Times* Book Prize for *Miracle's Boys*. She lives with her family in Brooklyn, New York. (Photo © Marty Umans)

Festival Authors

FICTION

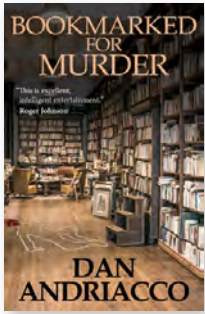

Dan Andriacco



Chuck Ayers
Tom Batiuk

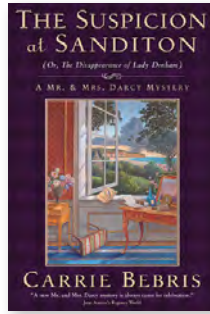

Carrie Bebris



Matt Betts

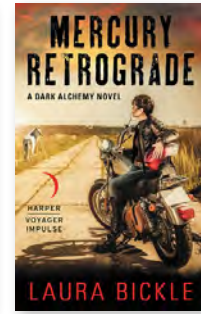

Laura Bickle

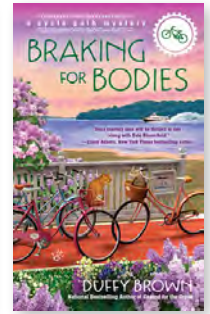

Duffy Brown



Lissa Bryan

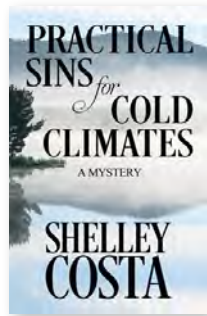

Shelley Costa



Alan Cupp



M.B. Earnhardt



Mary Ellis

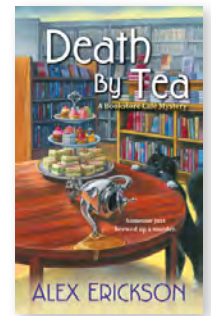

Alex Erickson

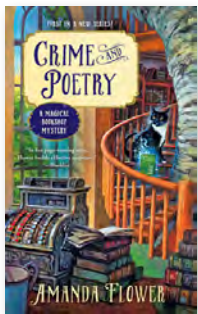

Amanda Flower

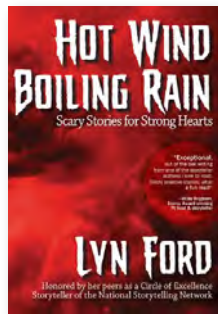

Lyn Ford



Robin Gianna

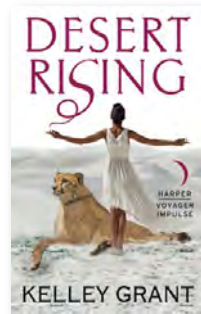

Kelley Grant



Karen Harper

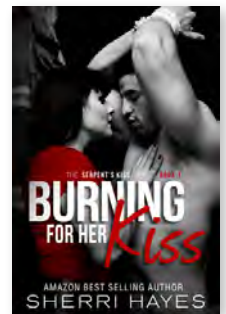

Sherri Hayes



John Hegenberger



Nancy Herriman



John B. Kachuba



Kevin P. Keating



Kylie Logan

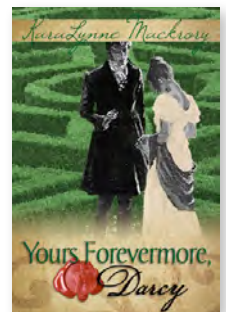

KaraLynne Mackrory



Donna MacMeans



Josef Matulich

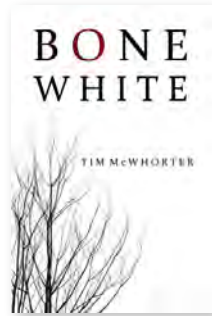

Tim McWhorter

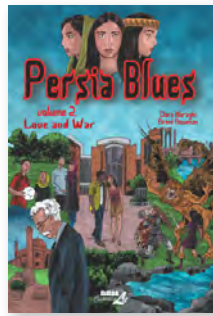

Dara Naraghi



Eliot Parker

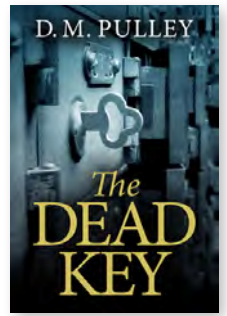

D.M. Pulley



Lisa Karon Richardson

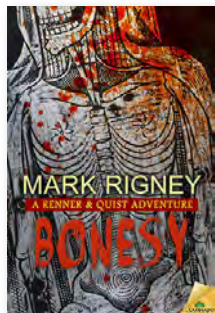

Mark Rigney



Yolonda Tonette Sanders



John Scalzi

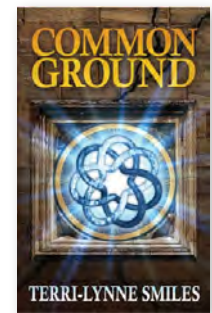

Terri-Lynne Smiles



Lucy A. Snyder

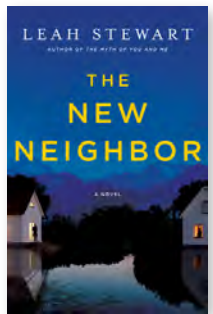

Leah Stewart



Alison Stine



Sam Thomas



Cindy Thomson



Tara Tyler



Andrew Welsh-Huggins

NONFICTION



Robin Yocum



R.G. Yoho

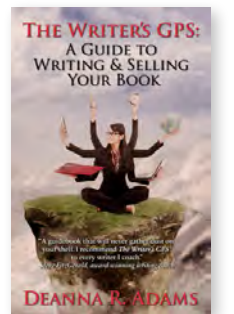

Deanna R. Adams

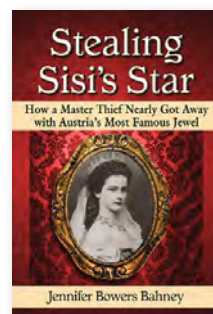

Jennifer Bowers Bahney

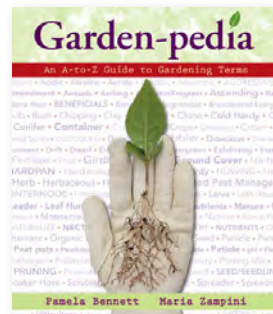

Pamela Bennett
Maria Zampini

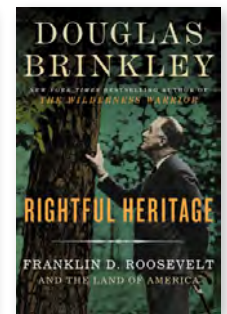

Douglas Brinkley

NONFICTION (cont.)

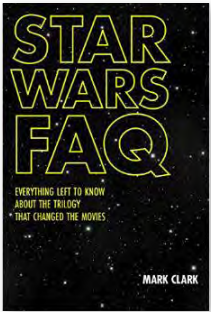

Mark Clark

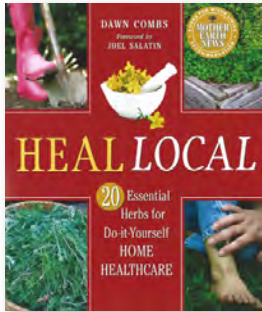

Dawn Combs

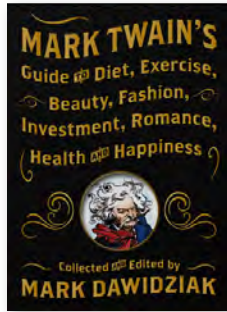

Mark Dawidziak

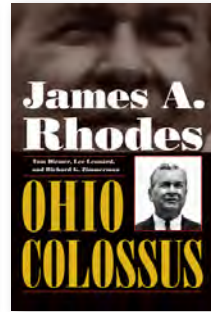

Tom Diemer
Lee Leonard

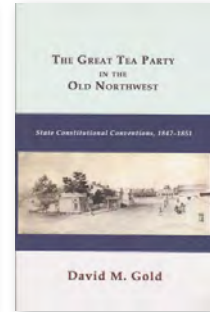

David M. Gold



Ann Hagedorn

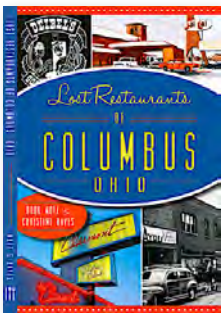

Christine Hayes
Doug Motz

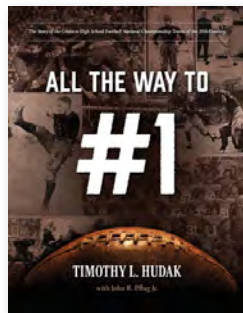

Timothy L. Hudak

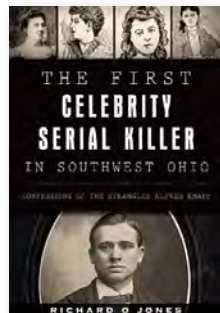

Richard O Jones



Jonathan Knight



Jeffrey J. Knowles



Wendy Koile

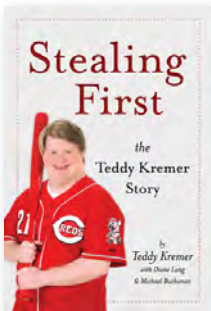

Teddy Kremer
Diane Lang

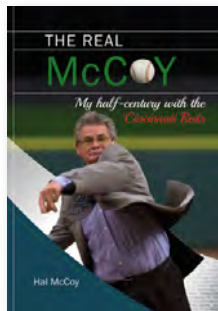

Hal McCoy



David Meyers

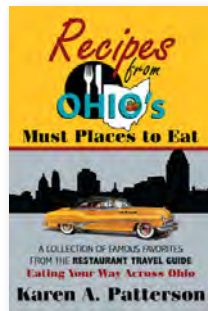

Karen A. Patterson

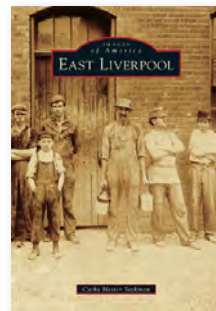

Cathy Hester
Seckman



Del Sroufe

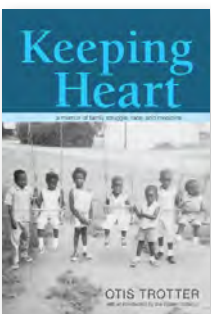

Otis Trotter



Jane Ann Turzillo



James A. Willis

POETRY

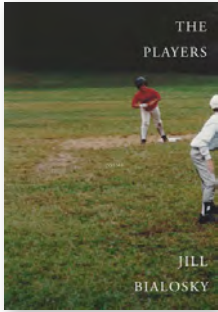

Jill Bialosky



Darren C. Demaree



John Philip Drury



Jeff Gundy

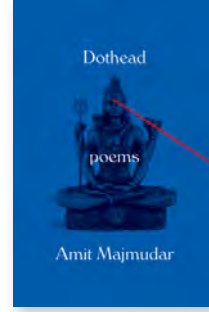

Amit Majmudar

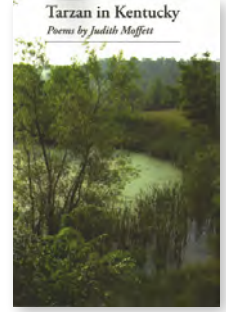

Judith Moffett

YOUNG ADULT

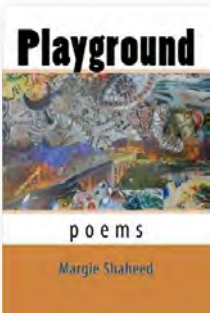

Margie Shaheed

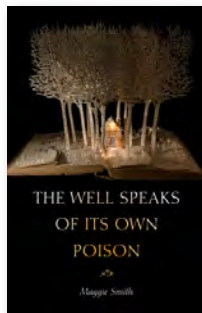

Maggie Smith



Colleen Clayton



Kurt Dinan



Julie Drew

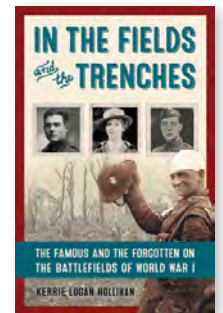

Kerrie Logan Hollihan



Tracy Lawson

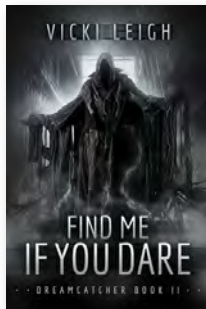

Vicki Leigh



Julie Anne Lindsey



Mindy McGinnis

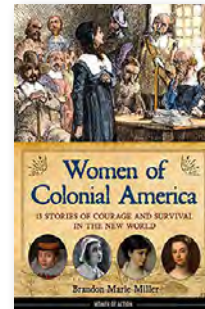

Brandon Marie Miller

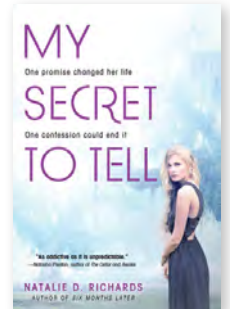

Natalie D. Richards

MIDDLE GRADE & CHILDREN'S



Rachele Alpine



Louise Borden

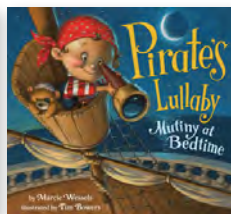

Tim Bowers

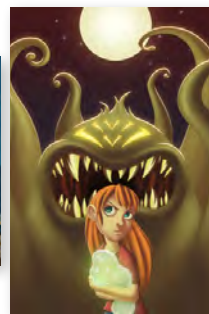

Gary Buettner

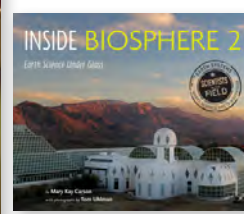

Mary Kay Carson



David Catrow

MIDDLE GRADE & CHILDREN'S (cont.)

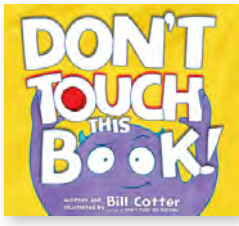

Bill Cotter



Jane Dippold



Marianne Dyson



Jeffrey Ebbeler

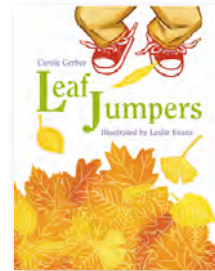

Carole Gerber

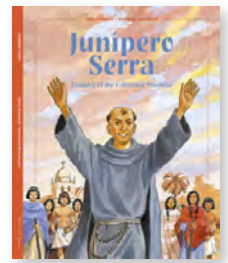

Linda Gondosch



Aiko Ikegami



Michele Jakubowski



Anne Vittur Kennedy



Karen Meyer

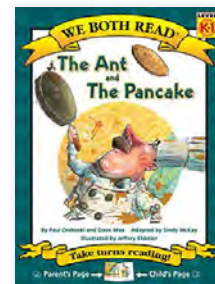

Paul Orshoski

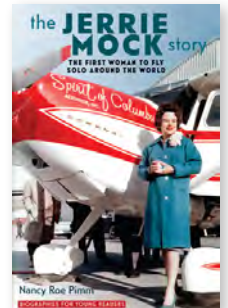

Nancy Roe Pimm



Rafael Rosado



Michael J. Rosen



Julie K. Rubini



Marilyn Sadler



Tricia Springstubb

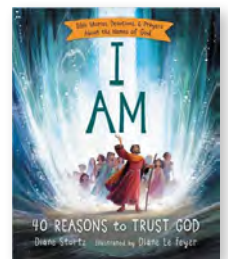

Diane Stortz



Connie Remlinger Trounstine



Carmella Van Vleet



Christina Wald



Kathy Cannon Wiechman

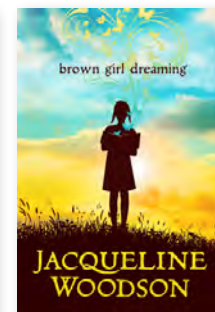

Jacqueline Woodson



The Ohioana Book Festival— something for every reader of every age!

KIDS' ROOM

AUTHOR/ILLUSTRATOR SESSIONS

- 10:30 Paul Orshoski
- 11:00 David Catrow
- 11:30 Lyn Ford
- 12:00 Aiko Ikegami
- 1:00 Christina Wald
- 1:30 Michele Jakubowski
- 2:00 Jeffrey Ebbeler
- 2:30 Connie Remlinger Trounstone
- 3:00 Bill Cotter
- 3:30 Karen Meyer

BALLOON TWISTING

10:30 a.m. - 3:30 p.m.

THROUGHOUT THE DAY

- Crafts
- Dress-Up Area
- Lego® Construction Zone
- Early Learning Area
- Door Prizes

TEEN SPACE

MAKERSPACE

11:00 a.m. - 2:00 p.m. Make projects including brown bag books, corner bookmarks, light-up gadgets, and recycled book page objects.

AUTHOR Q&A

11:30 a.m. - 12:15 p.m. with Colleen Clayton, Vicki Leigh, Julie Anne Lindsey & Brandon Marie Miller

SPEED DATING

12:45 p.m. - 1:30 p.m. with Kurt Dinan, Tracy Lawson, Mindy McGinnis & Natalie D. Richards

POETRY SLAM

2:00 p.m. - 2:45 p.m. Perform your own poetry with Michael J. Rosen & Jacqueline Woodson

POP-UP BATTLE OF THE BOOKS

3:15 p.m. - 4:00 p.m. Show your book smarts answering questions about YA books at the festival

THROUGHOUT THE DAY

Door Prizes

SPECIAL THANKS TO:

Stella Dickman
Janet Ingraham-Dwyer/State Library of Ohio
for their generous donation of books for door prizes

Author Panels & Roundtables

10:15 a.m. – 11:00 a.m.

Urban Fantasy and Dystopia

Matt Betts, Laura Bickle, Lissa Bryan, Josef Matulich,
Terri-Lynne Smiles
Legislative Room A

Mystery, Thrills, and Suspense I

Dan Andriacco, Shelley Costa, Yolonda Tonette Sanders,
Sam Thomas, Andrew Welsh-Huggins
Legislative Room B

Ohio Stories: People and Places

Christine Hayes, Doug Motz, Karen A. Patterson, Cathy
Hester Seckman, James A. Willis
House Room A

Writing and Publishing for Young Readers I

Louise Borden, Tim Bowers, Julie Drew, Linda
Gondosch, Rafael Rosado, Tricia Springstubb
House Room B

11:30 a.m. – 12:15 p.m.

From Another Realm: Paranormal, Science Fiction, and Fantasy

Kelley Grant, Dara Naraghi, John Scalzi, Tara Tyler
Legislative Room A

Extraordinary Men, Extraordinary Times: Roosevelt and Rhodes

Douglas Brinkley, Tom Diemer, Lee Leonard
Legislative Room B

The Power of Words: Poetry

Amit Majmudar, Michael J. Rosen, Maggie Smith, Alison
Stine, Jacqueline Woodson
House Room A

Plants: In the Garden and on the Table

Pamela Bennett, Dawn Combs, Del Sroufe,
Maria Zampini
House Room B

12:45 p.m. – 1:30 p.m.

How We Write, What We Write

Jill Bialosky, Mark Dawidziak, Amanda Flower, Leah
Stewart, Robin Yocum
Legislative Room A

Mystery, Thrills, and Suspense II

Carrie Bebris, Duffy Brown, Karen Harper, Nancy
Herriman, Kylie Logan
Legislative Room B

True Stories: The Strange and the Sensational

Jennifer Bowers Bahney, Richard O Jones, Wendy Koile,
David Meyers, Jane Ann Turzillo
House Room A

Writing Nonfiction for Young Readers

Mary Kay Carson, Marianne Dyson, Kerrie Logan
Hollihan, Nancy Roe Pimm, Julie K. Rubini,
Carmella Van Vleet
House Room B

2:00 p.m. – 2:45 p.m.

The Creative Life

Chuck Ayers, Tom Batiuk, David Catrow, Ann Hagedorn,
Mindy McGinnis
Legislative Room A

Horror, Suspense, and the Supernatural

Kevin P. Keating, Tim McWhorter, Mark Rigney,
Lucy A. Snyder
Legislative Room B

Historical Fiction: Stories Set in Real Places and Times

John B. Kachuba, Lisa Karon Richardson, Cindy
Thomson, R.G. Yoho
House Room A

Writing and Publishing for Young Readers II

Rachele Alpine, Carole Gerber, Anne Vittur Kennedy,
Brandon Marie Miller, Marilyn Sadler, Kathy Cannon
Wiechman
House Room B

3:15 p.m. – 4:00 p.m.

Publishing: The Insider’s Guide

Deanna R. Adams, Mark Clark, David M. Gold
Legislative Room A

Mystery, Thrills, and Suspense III

Alan Cupp, Mary Ellis, John Hegenberger, Eliot Parker,
D.M. Pulley
Legislative Room B

The Story Behind the Story: Fiction Roundtable

M.B. Earnhardt, Robin Gianna, Sherri Hayes,
KaraLynne Mackrory, Donna MacMeans
House Room A

Talking Sports

Timothy L. Hudak, Jonathan Knight, Teddy Kremer,
Diane Lang, Hal McCoy
House Room B

Poetry in the Plaza

1:30 p.m. – 3:45 p.m.

Hear festival poets recite and discuss
their poetry in a relaxed setting.

- 1:30 Darren C. Demaree
- 1:45 Judith Moffett
- 2:00 Margie Shaheed
- 2:15 Jeff Gundy
- 2:30 Alison Stine
- 2:45 Maggie Smith
- 3:00 John Philip Drury
- 3:15 Jill Bialosky
- 3:30 Amit Majmudar

Plaza Lounge (Second Floor)

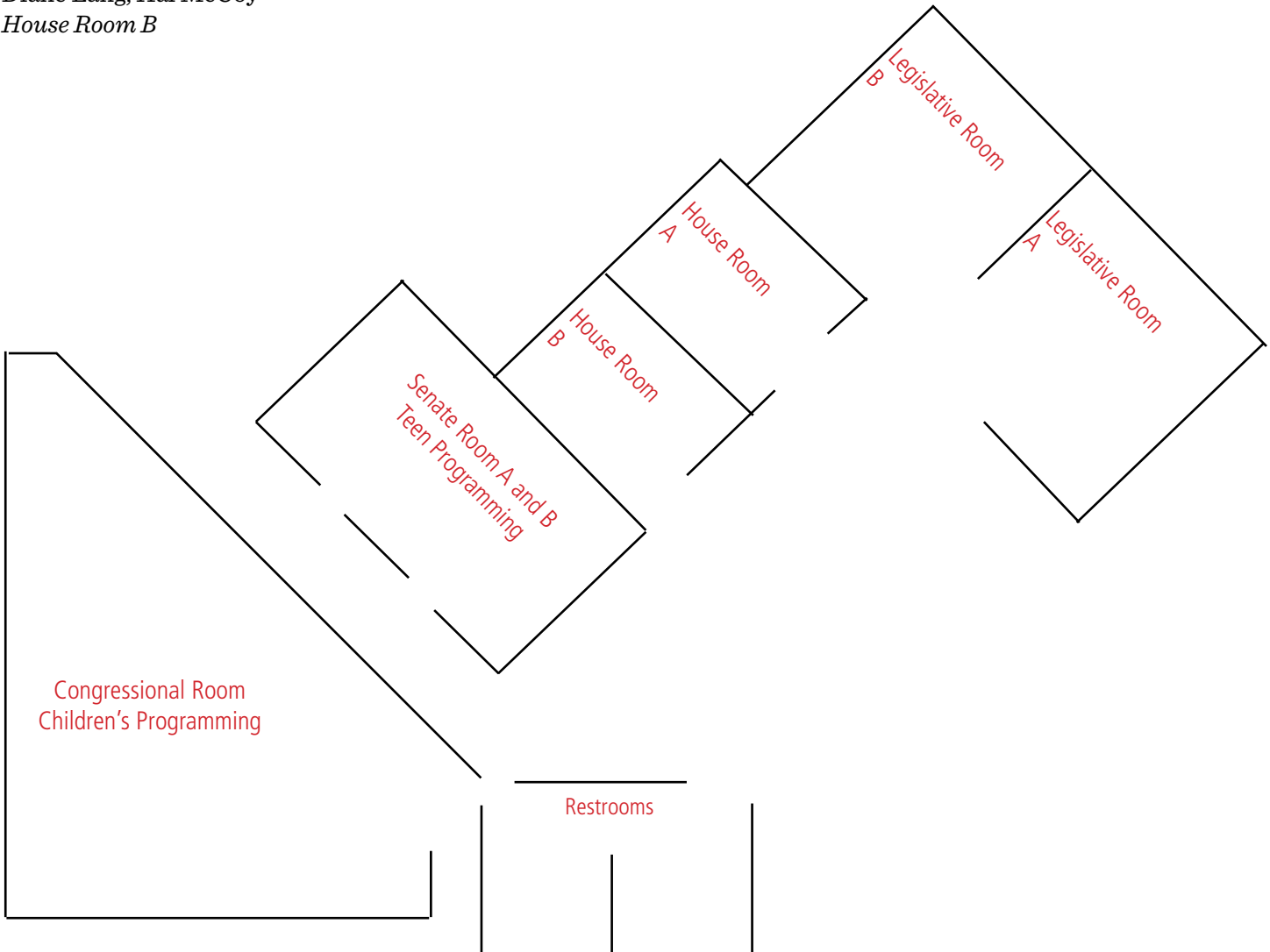

Authors

- Deanna R. Adams—Table 20
Rachele Alpine—Table 9
Dan Andriacco—Table 26
Chuck Ayers—Table 47
Jennifer Bowers Bahney—Table 34
Tom Batiuk—Table 47
Carrie Bebris—Table 46
Pamela Bennett—Table 16
Matt Betts—Table 44
Jill Bialosky—Table 29
Laura Bickle—Table 6
Louise Borden—Table 50
Tim Bowers—Table 14
Douglas Brinkley—Table 17
Duffy Brown—Table 42
Lissa Bryan—Table 45
Gary Buettner—Table 49
Mary Kay Carson—Table 56
David Catrow—Table 50
Mark Clark—Table 20
Colleen Clayton—Table 58
Dawn Combs—Table 15
Shelley Costa—Table 45
Bill Cotter—Table 15
Alan Cupp—Table 43
Mark Dawidziak—Table 19
Darren C. Demaree—Table 28
Tom Diemer—Table 18
Kurt Dinan—Table 8
Jane Dippold—Table 52
Julie Drew—Table 8
John Philip Drury—Table 21
Marianne Dyson—Table 56
M.B. Earnhardt—Table 25
Jeffrey Ebbeler—Table 10
Mary Ellis—Table 41
Alex Erickson—Table 42
Amanda Flower—Table 41
Lyn Ford—Table 4
Carole Gerber—Table 13
Robin Gianna—Table 24
David M. Gold—Table 19
Linda Gondosch—Table 51
Kelley Grant—Table 6
Jeff Gundy—Table 30
Ann Hagedorn—Table 17
Karen Harper—Table 40
Christine Hayes—Table 35
Sherri Hayes—Table 24
John Hegenberger—Table 27
Nancy Herriman—Table 40
Kerrie Logan Hollihan—Table 57
Timothy L. Hudak—Table 39
Aiko Ikegami—Table 52
Michele Jakubowski—Table 9
Richard O Jones—Table 31
John B. Kachuba—Table 2
Kevin P. Keating—Table 44
Anne Vittur Kennedy—Table 53
Jonathan Knight—Table 39
Jeffrey J. Knowles—Table 37
Wendy Koile—Table 32
Teddy Kremer—Table 38
Diane Lang—Table 38
Tracy Lawson—Table 59
Vicki Leigh—Table 59
Lee Leonard—Table 18
Julie Anne Lindsey—Table 58
Kylie Logan—Table 46
KaraLynne Mackrory—Table 23
Donna MacMeans—Table 25
Amit Majmudar—Table 29
Josef Matulich—Table 61
Hal McCoy—Table 37
Mindy McGinnis—Table 7
Tim McWhorter—Table 61
Karen Meyer—Table 54
David Meyers—Table 31
Brandon Marie Miller—Table 57
Judith Moffett—Table 30
Doug Motz—Table 35
Dara Naraghi—Table 48
Paul Orshoski—Table 10
Eliot Parker—Table 27
Karen A. Patterson—Table 36
Nancy Roe Pimm—Table 55
D.M. Pulley—Table 1
Natalie D. Richards—Table 7
Lisa Karon Richardson—Table 22
Mark Rigney—Table 4
Rafael Rosado—Table 49
Michael J. Rosen—Table 53
Julie K. Rubini—Table 54
Marilyn Sadler—Table 14
Yolonda Tonette Sanders—Table 43
John Scalzi—Table 5
Cathy Hester Seckman—Table 33
Margie Shaheed—Table 28
Terri-Lynne Smiles—Table 60
Maggie Smith—Table 21
Lucy A. Snyder—Table 5
Tricia Springstubb—Table 11
Del Sroufe—Table 36
Leah Stewart—Table 2
Alison Stine—Table 22
Diane Stortz—Table 51
Sam Thomas—Table 26
Cindy Thomson—Table 23
Otis Trotter—Table 34
Connie Remlinger Trounstone—Table 12
Jane Ann Turzillo—Table 32
Tara Tyler—Table 60
Carmella Van Vleet—Table 55
Christina Wald—Table 13
Andrew Welsh-Huggins—Table 1
Kathy Cannon Wiechman—Table 12
James A. Willis—Table 33
Jacqueline Woodson—Table 11
Robin Yocum—Table 3
R.G. Yoho—Table 3
Maria Zampini—Table 16

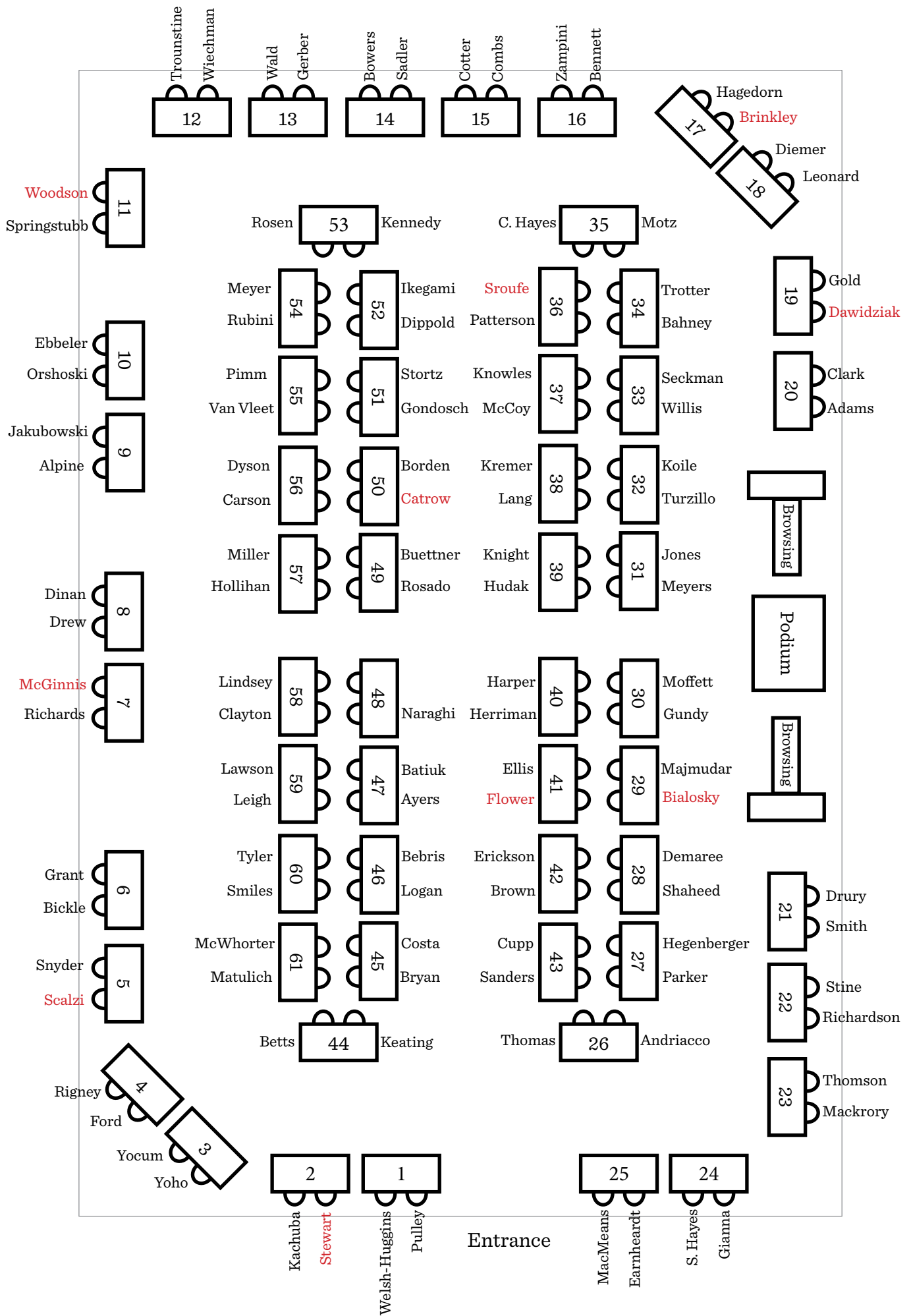

PRESENTING SPONSORS



SPONSORS



CHILDREN'S PROGRAMMING



MEDIA PARTNERS

BOOKSELLER



PARTNERS

